

# LUNA-GLOB ORBITER

A.A. Petrukovich

IKI RAN

preview



# LUNA-GLOB MISSION



## ORBITER

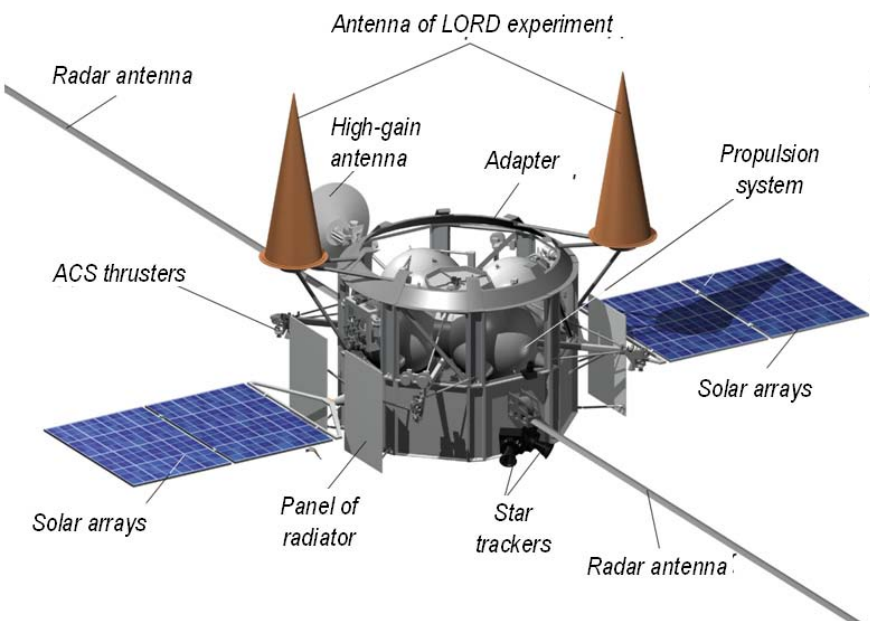

Launcher	"Soyuz-2/1b" Launcher "Fregat" upper stage
Launch year	2014
Spacecraft composition	<ul style="list-style-type: none"> <li>• Orbiter</li> <li>• Lander</li> </ul>
Spacecraft mass	2 967 kg
Orbiter mass	1 657 kg
Lander mass	1 260 kg
Lander communication with the Earth	Directly to the Earth
Mass of scientific equipment on the orbiter	120 kg
Mass of scientific equipment on the lander	50 kg



# LUNA-GLOB ORBIT

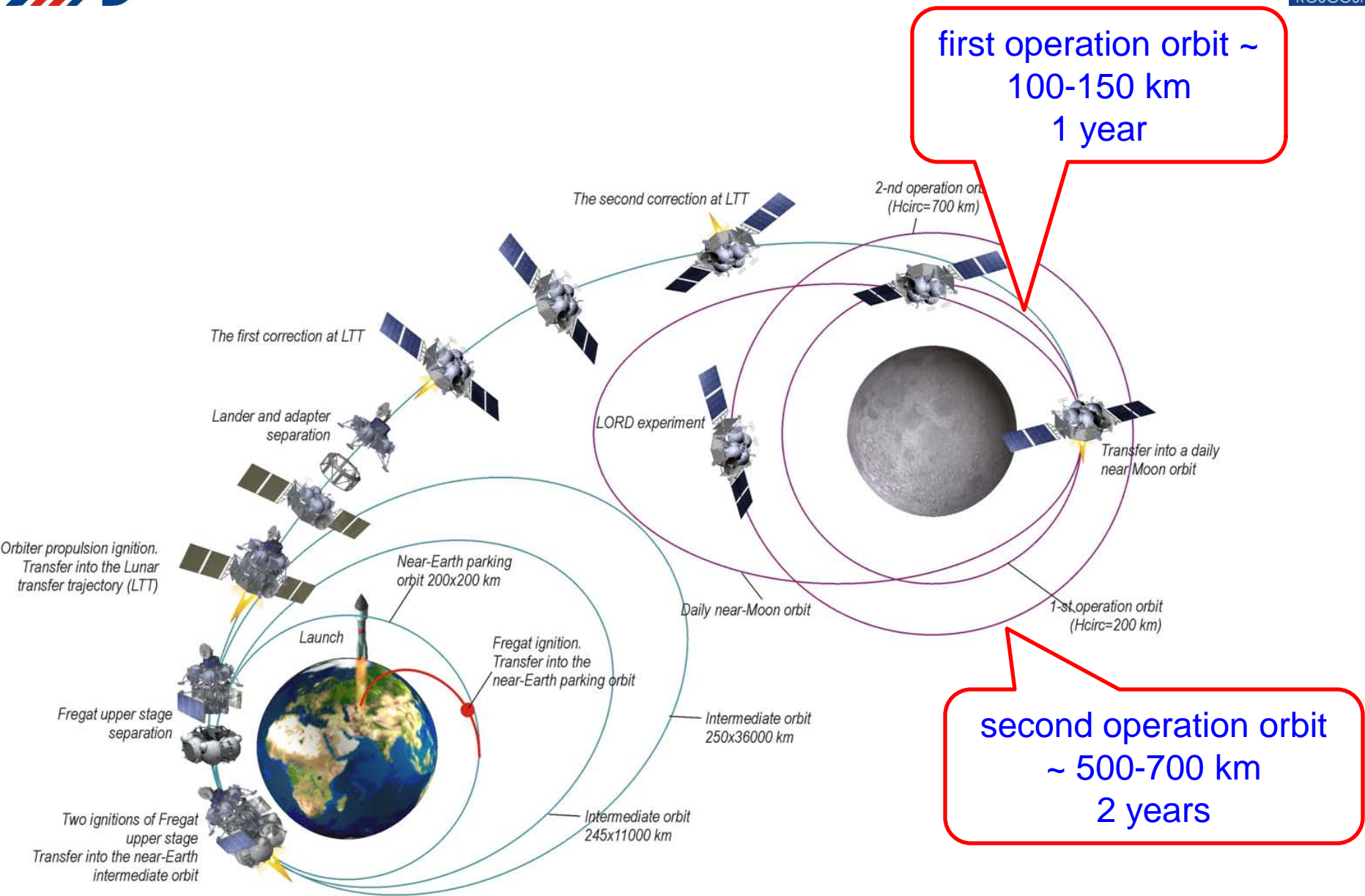



# LUNA-GLOB EXPERIMENTS



## 1. nadir-looking experiments

**LGNS**

neutron and gamma ray

**IKI RAN**

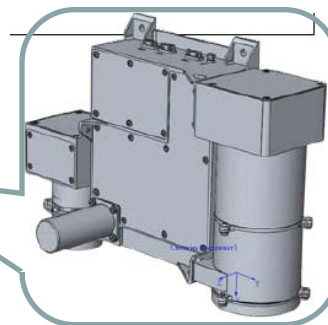

**LEVUS**

UV exosphere  
30-150 nm with scanner

**France/Japan/IKI**

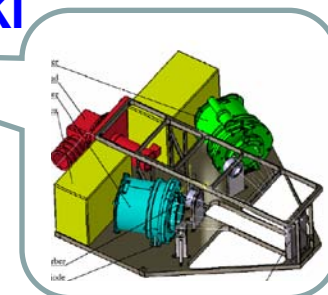

**LUMIS**

IR mapping  
1-16 mkm

**IKI**

**LSTK**

stereo camera

**IKI**

**RLK-L**

radar  
20 and 200 MHz

**IRE**





# LUNA-GLOB EXPERIMENTS



## 2. circumlunar plasma science

**LPMS-LG**

magnetometer  
DC field

**IKI RAN**

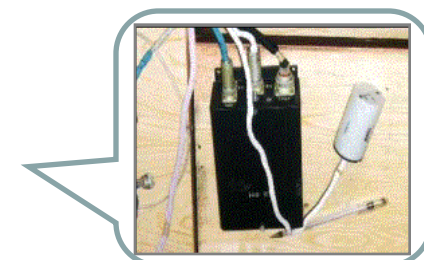

**LEMI**

electromagnetic waves  
magnetic fluctuations to 40 kHz

**Ukraine/Czech/IKI**

**BMSW-LG**

solar wind  
plasma flow direction, velocity, density

**Czech/IKI**



**ASPECT-L**

energetic particles  
ions and electrons 20-1000 keV

**Slovakia/IKI**

**LINA**

ions and neutral spectrometer  
major ion species 10-30 000 keV

**IKI/Sweden**





# LUNA-GLOB EXPERIMENTS



## 3. other

**RLK-L**

**radio receiver**

**IKI**

high-precision orbit measurements

**LORD**

ultra-high energy cosmic rays

**FIAN**

moon as natural telescope

**METEOR-L**

circumlunar dust

**GeoKhi**

**SSRNI2**

data management system

**IKI**

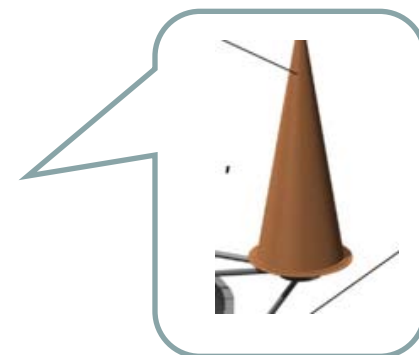

## Moon surface science

- Topography (camera & radar)
- Subsurface structure (radar)
- Hydrogen rich regions (LGNS & LUMIS)
- Chemical composition (LGNS & LUMIS)
- Moon gravity field (radio)

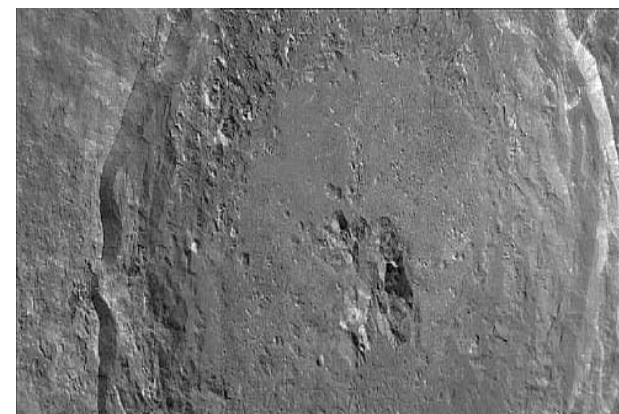
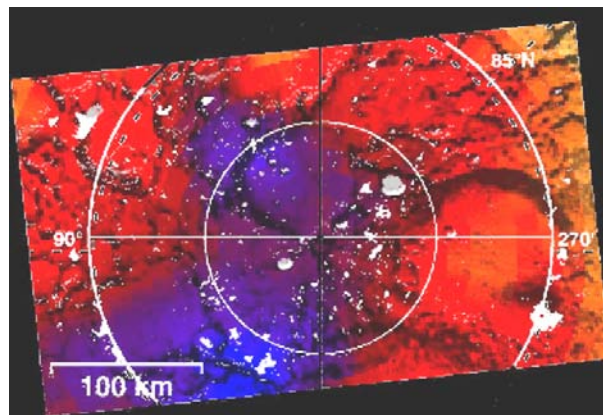
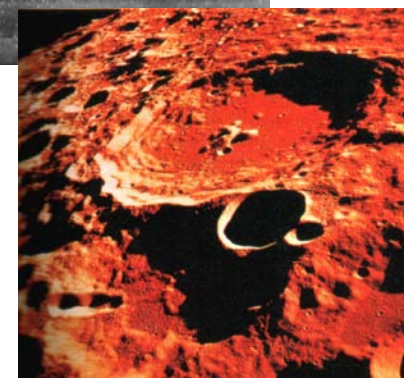
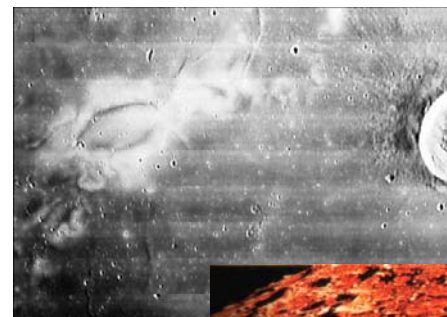

## Circumlunar science

- Exosphere (LEVUS & LIMA)
- Solar wind – moon interaction
- Lunar magnetic anomalies
- Micrometeors (METEOR)

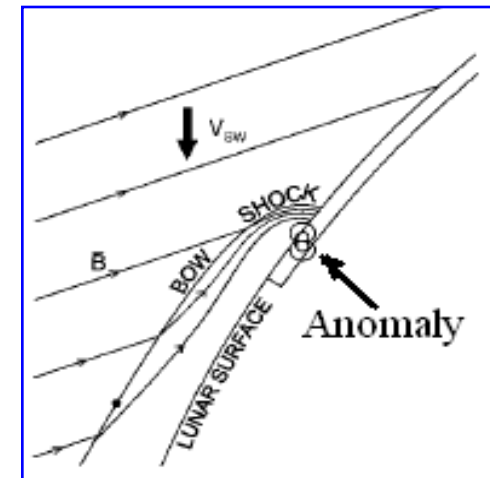
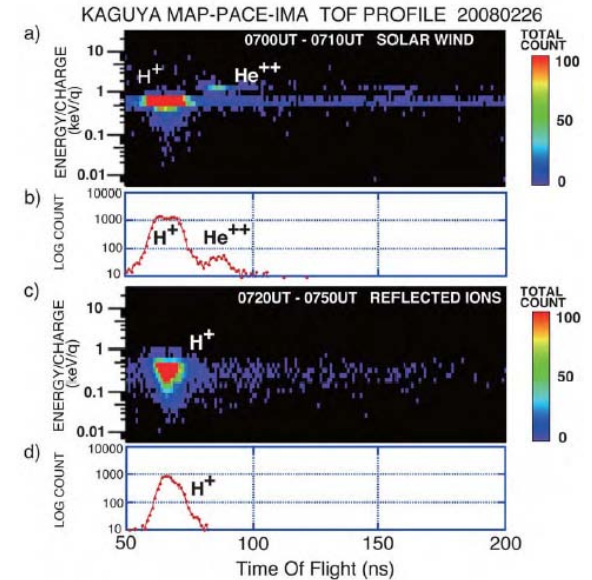
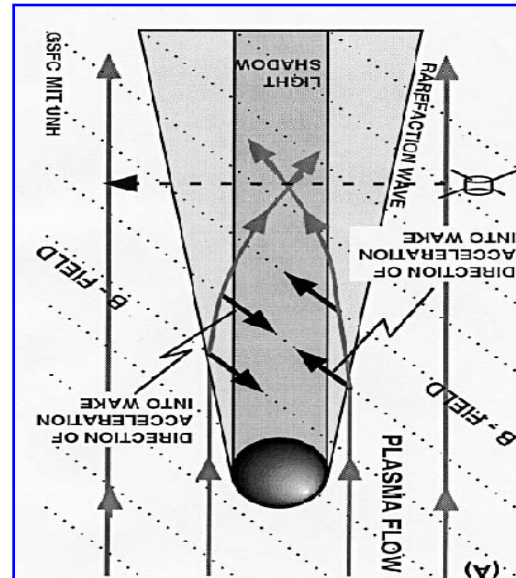
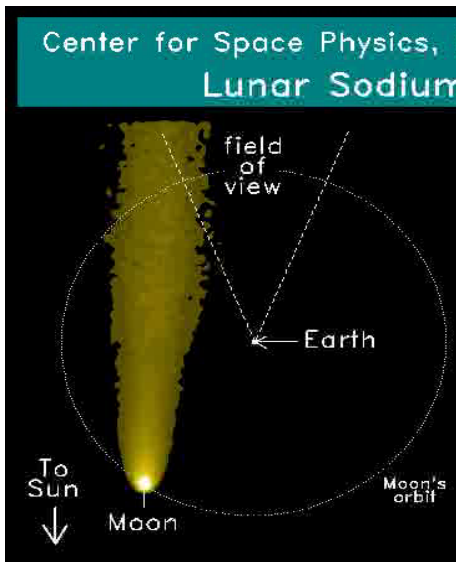



## Other science

- Solar wind and magnetotail dynamics
- Ultra-high energy cosmic rays
- UV imaging of heliosphere

